

The 4 Ports Full Gigabit PoE++ Switch PoE switch is an unmanaged PoE switch, which provides 2 optical, 2 uplink copper ports and 4 Gigabit PoE downlink Ethernet ports, where in 1 optical and 1 copper port are Combo ports. The PoE port 1 support 60W HPOE with microsemi solution. It supports the 60W high power PoE+ surveillance cameras. The PoE port 2-4 are 30W PoE ports. The switch can be widely used in security network video surveillance, network engineering and other occasions.

Application

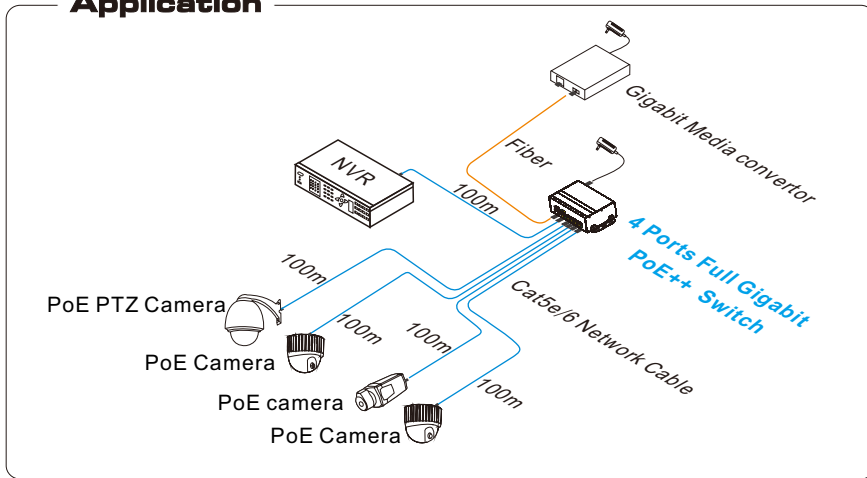

Feature

- Standard: IEEE802.3 ,IEEE802.3u ,IEEE802.3ab,IEEE802.3z,IEEE802.3 af/at;
- Provide gigabit 2 optical and 2 copper uplink ports, wherein 1 optical port and 1 copper port are Combo ports;
- Provide 4x10/100/1000Mbps adaptive downlink PoE ports, port 1 is 60W HPOE,2 to 4 ports are 30W ports , all 4 ports support IEEE802.3 af/at ;
- Redundant power design, support power hot backup, standard DC port and green terminal port, Support power adapter with different connectors and power;
- Support -40 to +75°C working temperature;
- Support 6KV surge protection,8KV/15KV ESD protection;
- Fanless wavy metal shell with heat dissipation design ;
- Fast installation and easy operation, convenient for wall, DIN-rail and desktop installation.

Caution

- 1) Transmission distance is related to the connecting cable. We suggest to use standard Cat5e/6 network cable to get the farthest transmission distance.
- 2) If using optical port, customer need to purchase SFP module additionally;
- 3) The equipment must connect anti-thunder ground, otherwise equipment protection will greatly reduced; please use 20AWG or thicker wire to connect grounding terminal to the ground.

Board diagram

4 ports Gigabit Ethernet PoE/HPOE switch

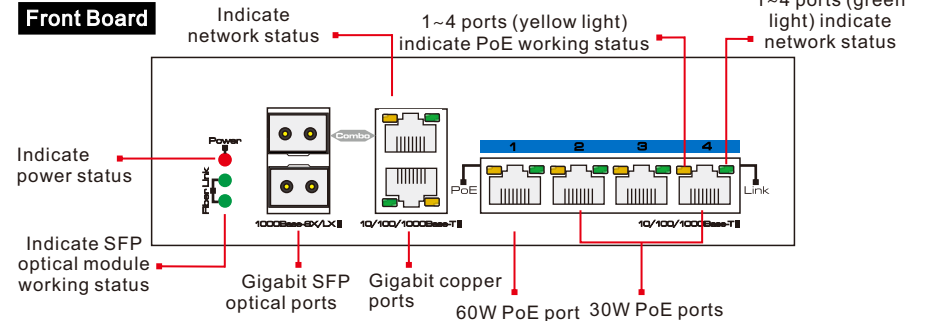

Left board

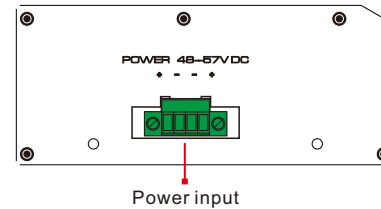

Back board

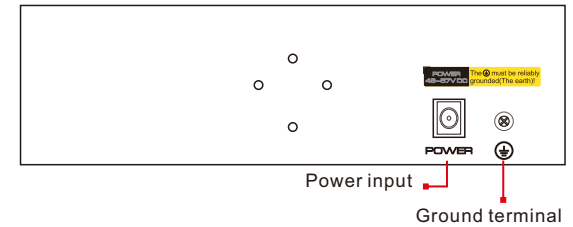

Installation steps

Please check the following items before installation. If any missing, please contact the dealer.

- Switch 1pc
- Power adapter 1pc
- Wall-Hanger 2pcs
- DIN-rail hanger 1pc
- User manual 1pc

Power supply connection

Left board

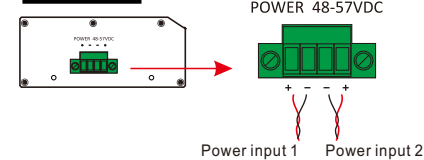

Back board

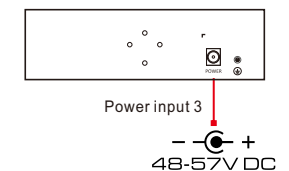

DIN-rail installation

Installation process:

- (1) Install the Din-rail hanger to the switch;
- (2) Install the switch to the DIN-rail ;

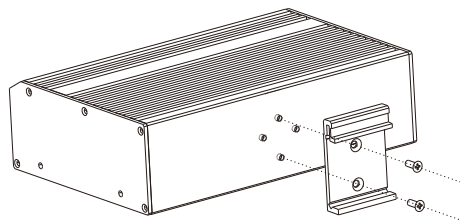

Wall-hunger installation

You can install the switch to the clean and stable wall.

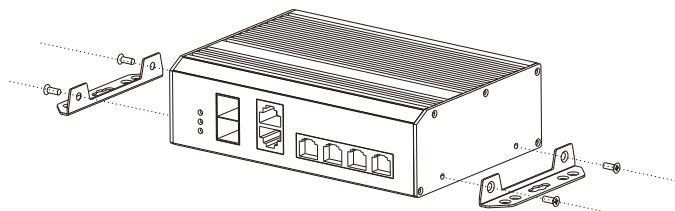

Installation step

- 1) Please turn off the signal source and the device's power, installation with power on may damage the device;
- 2) Use 4 network cables to connect 4 IP cameras and 1~4 RJ45 ports of switch;
- 3) Use another network cable (or optical fiber) to connect switch's uplink port with NVR or computer, etc.;
- 4) Connect equipment with power adapter;
- 5) Check if the installation is correct and device is good, make sure all the connection is reliable and power up the system;
- 6) Make sure every network device has power supply and work normally.

■ Trouble Shooting

Please find the following solution when the device doesn't work

- Please confirm if the installation is correct;
- Please confirm if the RJ45 cable order is in accordance with the EIA/TIA568A or 568B industry standards;
- It can not exceed the maximum watts of each port,60W for port 1 and 30W for port 2 to 4 ;
- Please replace a failure device with a normal one to check if the device is broken;
- If the problem still exist, please contact the factory.

■ Specification

Item		4 Ports Full Gigabit PoE++ Switch
Power	Power supply	power adapter
	Voltage range	DC48V~57V
	Consumption	≤5W Self-consumption
Network port parameters	Ethernet port	SFP optical port: 1000Mbps Copper port: 10/100/1000Mbps
	Transmission distance	Copper port: 100m; SFP optical port: depend on the optical module transmission performance
	transmission medium	Cat5e/6 standard network cable
	PoE agreement	IEEE802.3af, IEEE802.3at agreement
	PoE ports	Port 1 ≤60W, 4-wire microsemi solution; Port 2 to 4 ≤30W, 2-wire microsemi solution
Network exchange specification	Network standard	IEEE802.3, IEEE802.3u, IEEE802.3ab, IEEE802.3z
	Switch architecture	Store and forward
	Package data buffer	1M
	MAC address table	8K
Status indicator	Power indicator	1 indicate power (Red)
	Optical port LED indicator	2 Fiber Link Green lights indicate fiber working status
	Uplink Ethernet port LED indicator	RJ45 indicates network working status
	Downlink Ethernet port LED indicator	1 ~ 4 ports with green LEDs indicate network status, yellow LEDs indicates PoE
Protection level	Surge protection	6KV, Standard: IEC61000-4-5
	ESD	Grade 4(8KV/15KV), Standard: IEC61000-4-2
Environmental	Working temperature	-40°C~75°C
	Storage temperature	-40°C~85°C
	Humidity (non-condensing)	0~95%
Mechanical	Dimension (L×W×H)	110mm×163mm×46mm
	Material	Aluminum
	Color	Black
	Weight	530g

Products are subject to change without prior notice